

S-SERIES, E-SERIES & T-SERIES STRAIGHT SHOT HOT SPRUE BUSHINGS

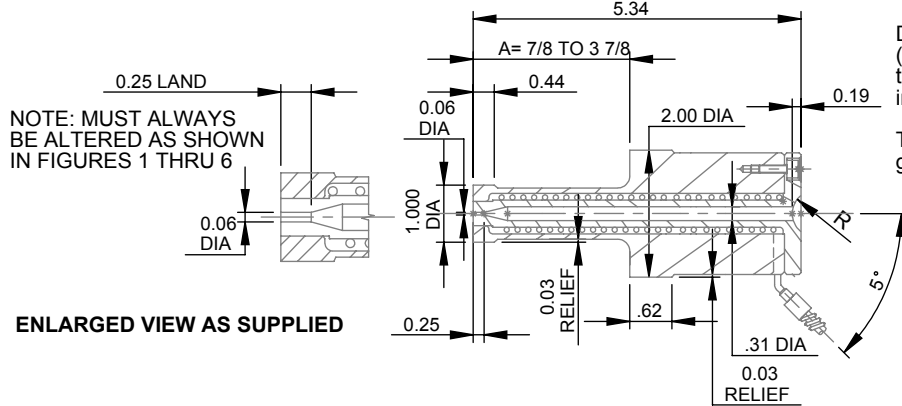

Note: Dimensions shown in Inches.

E-SERIES (LONG STYLE)



D-M-E Standard E-Series Straight-Shot Hot Sprue Bushings (Long and Short Styles) provide .25 extra stock allowance on the front face to permit machining runner profiles or part contours into that face.

They are supplied with a .06 diameter gate and a .25 gate land. The gate diameter can be enlarged to suit the particular molding application.

The D-M-E Standard E-Series Straight shot (Long-Style) is available in seven standard shoulder lengths with either a 1/2 or 3/4 spherical radius and 120 or 240 volt heater. The E-Series Straight-Shot (Long Style) can be retrofitted to suit the particular molding application.

NOTE: The 5° heater lead is standard. A 90° heater lead is available on special request.

E-SERIES (SHORT STYLE)

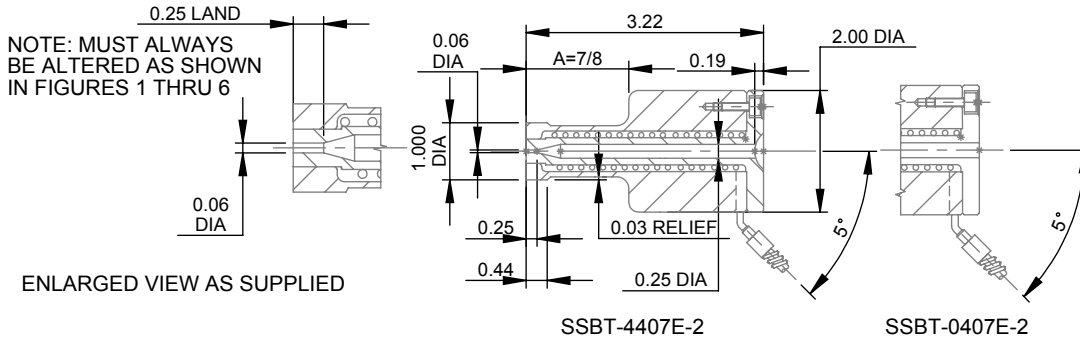

The D-M-E Standard E-Series Straight Shot (Short-Style) is intended to suit the requirement of smaller injection molding machines such as Aburg Boy and Jaco. It is supplied with a 7/8 "A" dimension. The "A" dimension can be altered to suit the particular molding application.

NOTE: The 5° heater lead is standard. A 90° heater lead is available on special request.

DESIGN GUIDELINES FOR ALTERING E-SERIES STRAIGHT - SHOT HOT SPRUE BUSHINGS (Long and Short Styles).

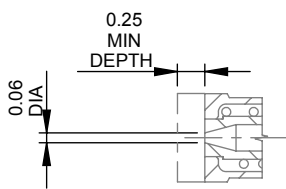

FIG. 1

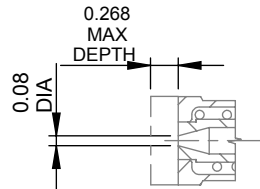

FIG. 2

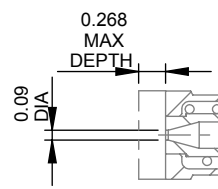

FIG. 3

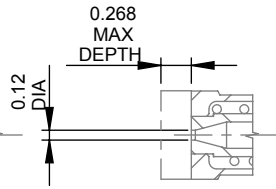

FIG. 4

Always remove the 0.25 extra stock allowance and alter the "A" dimension to suit whenever gating into flat surface. Minimum stock removal of 0.25 provides and approximate 0.06 gate diameter (Figure 1).

Maximum stock removal of 0.268 provides an approximate 0.08 gate diameter (Figure 2). Maximum stock removal of 0.268 is recommended for gate diameters larger than 0.08 (Figures 3 and 4).

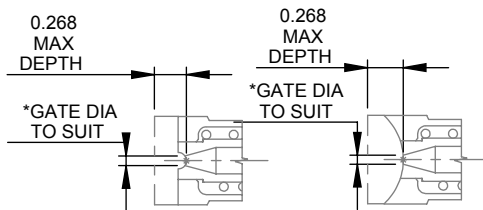

FIG. 5

FIG. 6

Always machine runner profile or part contour to the 0.268 maximum depth at centerline of gate (Figures 5 and 6). However, do not weaken the bushing face by exceeding this maximum dimension. *Resultant gate diameter may be enlarged to suit the particular molding application.

D-M-E SHALL NOT BE LIABLE FOR MISUSE OR FAILURE TO FOLLOW THE ENCLOSED INSTRUCTIONS AND SPECIFICATIONS. D-M-E HERBY TO DISCLAIM ALL IMPLIED WARRANTIES, INCLUDING MERCHANTABILITY AND FITNESS FOR A PARTICULAR PURPOSE. IN NO EVENT SHALL D-M-E BE RESPONSIBLE FOR LOSS OF USE, REVENUE OR PROFIT, OR FOR INCIDENTAL OR CONSEQUENTIAL DAMAGED.

S-Series straight-Shot

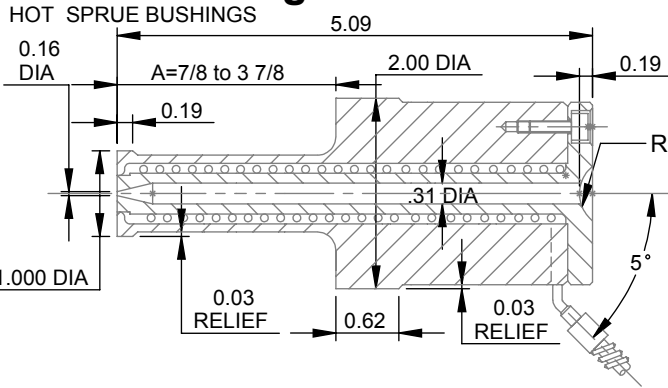

The standard S-Series Straight-Shot is designed for direct part gating or for feeding half round or trapezoidal runners. It is supplied with a 0.16 diameter gate and no gate land. It is available in seven standard shoulder lengths with either a 1/2 or 3/4 spherical radius and 120 or 240 volt heater. The S-Series Straight-Shot can be retrofitted to almost any mold that uses a conventional sprue bushing.

NOTE: The 5° heater lead is standard.
 A 90° heater lead is available on special request.

T-Series straight-Shot

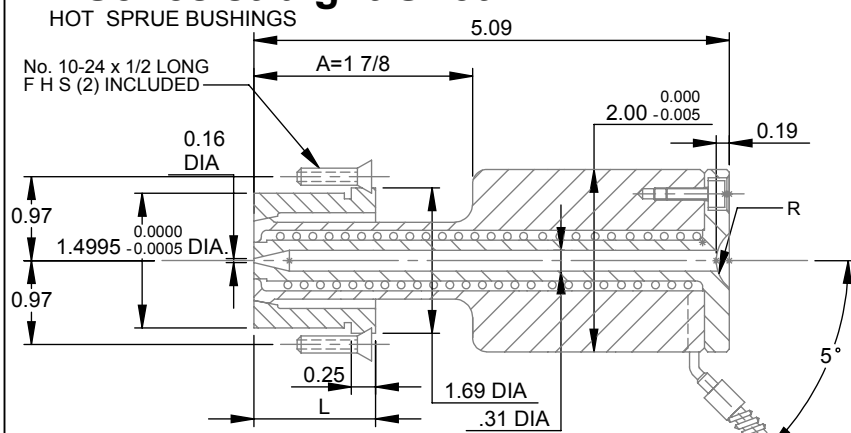

The D-M-E Standard T Series Straight-Shot improves the performance of the three-plate molds by virtually eliminating the sprue from the runner system. It is available with either 1/2 or 3/4 spherical radius, 120 or 240 volt heater and a 7/8 or 1 3/8 long stripper plate bushing to suit the application.

NOTE: The 5° heater lead is standard.
 A 90° heater lead is available on special request.

REPLACEMENT HEATERS FOR STRAIGHT-SHOT HOT SPRUE BUSHINGS

STANDARD

CATALOG NUMBER	VOLTS	WATTS	L	BUSHING SERIES
SSTC-31	120	300	4 5/8	S, E (Long style) & T
SSTC-32	240	300	4 5/8	S, E (Long style) & T
SSTC-42	240	250	2 1/2	E (Short style)

REPLACEMENT HEATERS FOR STRAIGHT-SHOT HOT SPRUE BUSHINGS AVAILABLE ON REQUEST

CATALOG NUMBER	VOLTS	WATTS	L	BUSHING SERIES
SSTC-31-90	120	300	4 5/8	S, E (Long style) & T
SSTC-32-90	240	300	4 5/8	S, E (Long style) & T
SSTC-42-90	240	250	2 1/2	E (Short style)

WARNING: Green ground wire must be connected to ground.

WIRING INFORMATION

Square Coil Heaters are supplied with 45" long leads. Heaters are 240 VAC or 120 VAC depending on the configuration.
 2 power leads are Multi Color.
 1 ground lead is GREEN.

Thermocouple is "J" Type.
 Thermocouple is supplied with 45" leads.
 1 T/C lead is WHITE and negative (-) constantan (non-magnetic).
 1 T/C lead is BLACK and positive (+) iron (magnetic).

IMPORTANT SAFETY INFORMATION

A hot-runner system includes electrical elements and may contain molten plastic at elevated temperature and pressure. To avoid injury, exercise caution by reading these instructions before servicing or operating the system.

These instructions must be passed on to the end user where they should be read before using this product. Failure to do so can result in serious injury or death.



Failure to comply will result in serious injury or death:
ELECTRICAL HAZARDS

Improper voltages or grounding can result in electrical shock. Use only with proper voltage and a proper earth ground.
 To avoid electrical shock, do not operate product when wet.
 Do not operate this equipment with covers or panels removed.
 To avoid electrical shock, turn off main power disconnect and lockout / tag out before servicing this device. Do not connect temperature sensors to electrical power. It will damage the product and it can cause fire, severe injuries or even death.
 If green ground wire present wire must be connected to the ground.
 Do not rebend rigid leads. Rebending leads might result in damage to circuit.
 Product might absorb moisture when cool. Use low Voltage or power to drive out residual moisture before applying full power. Failure to do so may cause damage to this product.



Failure to comply can result in serious injury or death:
STORED ENERGY AND HIGH TEMPERATURE HAZARDS

This product maintains molten plastic at high pressure. Use caution when operating and servicing the system.
 Physical contact with molten plastic may result in severe burns. Proper protective equipment, including eye protection, must be worn.
 This product has heated surfaces. Use caution when operating and servicing the system to avoid severe burns. Proper protective equipment should be worn.

NOTE: DME Standard E-Series Straight Shot Hot Sprue Bushing(short style)(SSTC-42/SSTC-42-90)not recommended to be used with DME type SSM-15-02 and DSS-15-02 temperature controllers.

INSTALLATION DATA

D-M-E Standard Straight-Shot

HOT SPRUE BUSHINGS

SHADED AREAS DIMENSIONED WITH "X" MAY BE REDUCED IN DIAMETER AS SHOWN, TO PROVIDE ADDITIONAL RELIEF.

Excessive contact between the 1" and 2" outside diameters of the Straight-Shot and matching 1" and 2" bores in the mold base may result in a heat loss, causing repeated bushing freeze off. If freeze off due to heat loss should occur, the Straight-Shot Hot Sprue Bushings may be relieved as shown. Minimize the amount of O.D. bushing contact to the mold, leaving sufficient contact on the 1" and 2" diameters to assure flash-free molding and proper support. This will help insulate and keep the heat in the bushing.

PLEASE READ CAREFULLY BEFORE INSTALLATION

